

FIG. 1

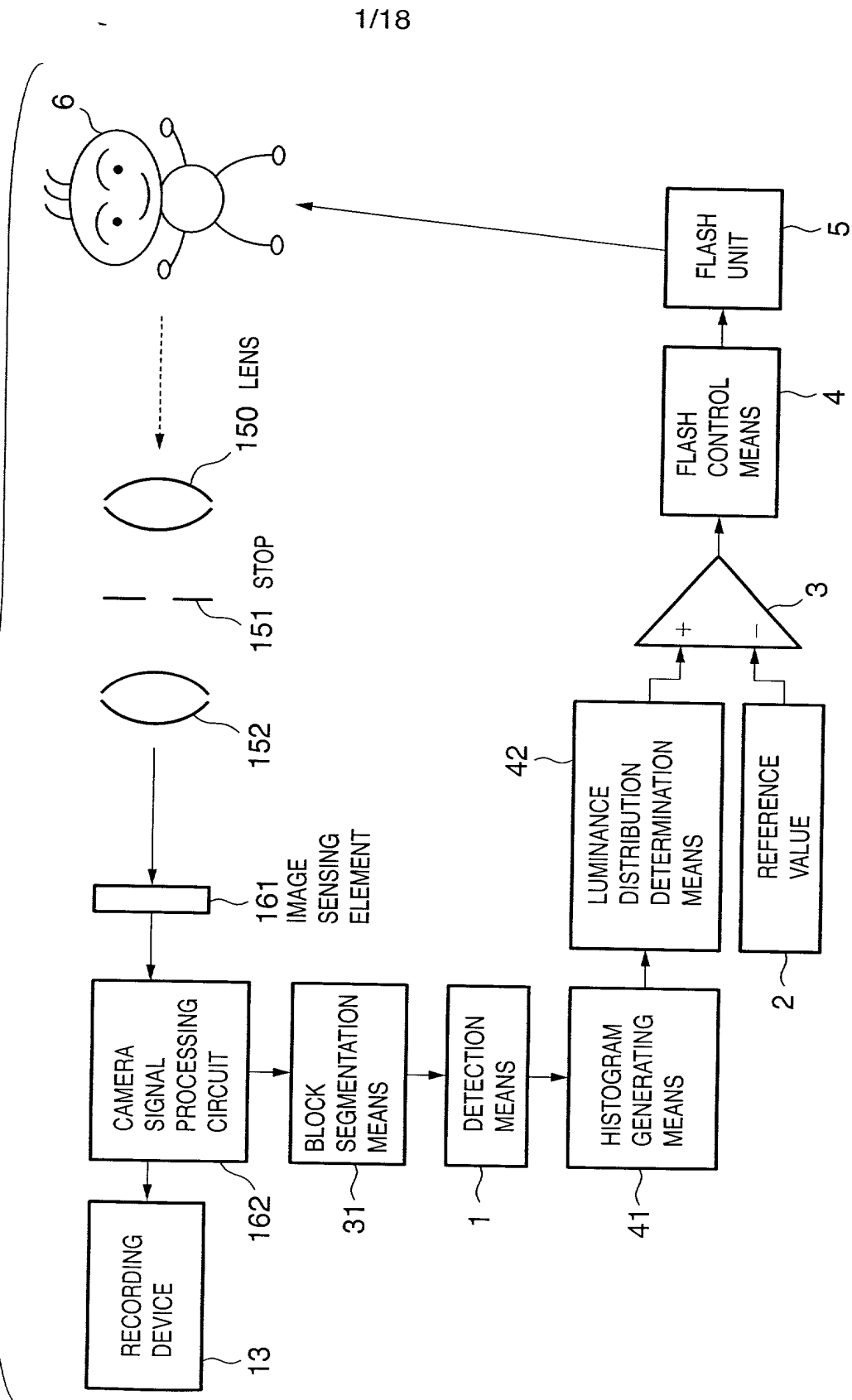

FIG. 2

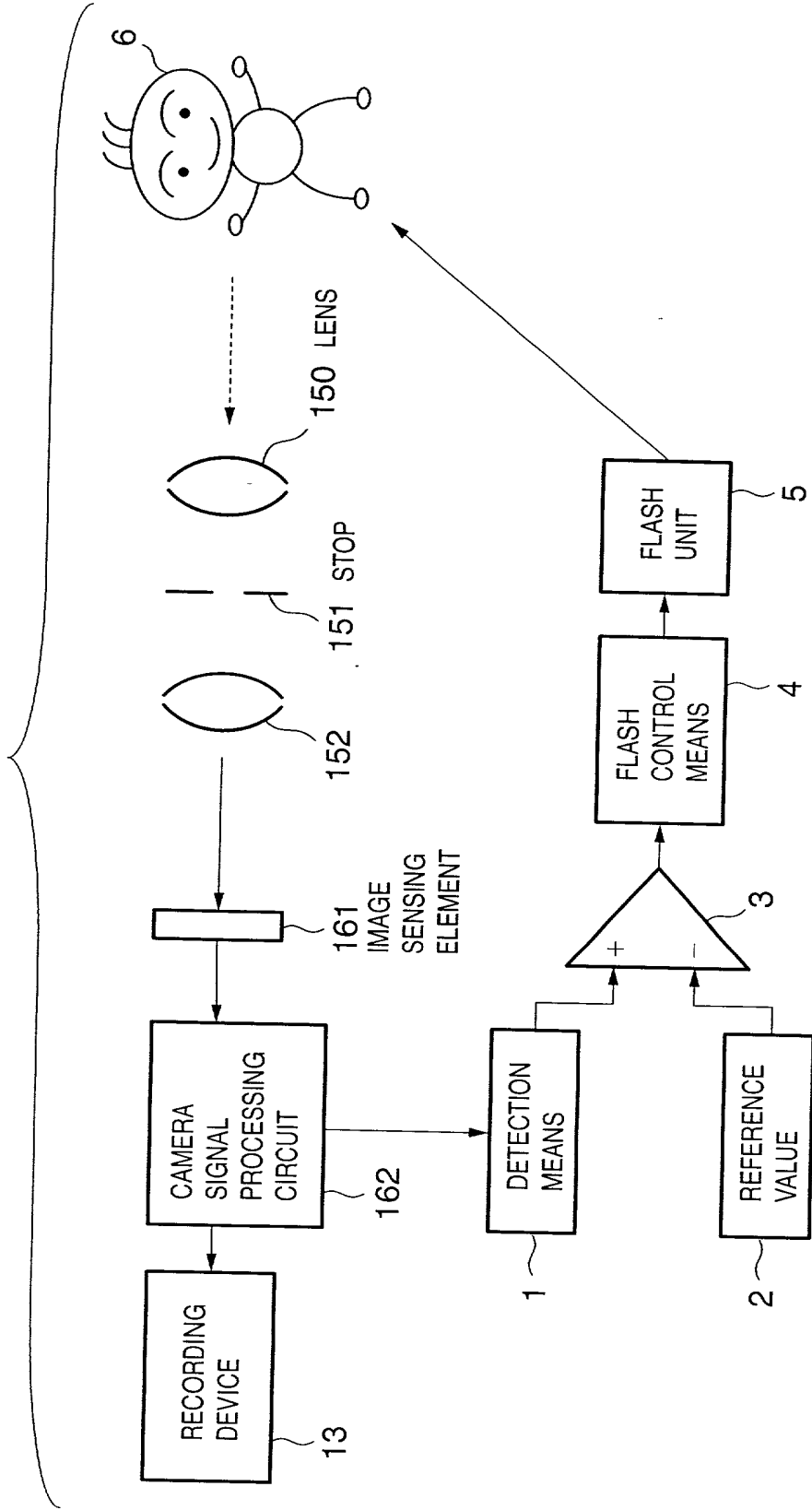
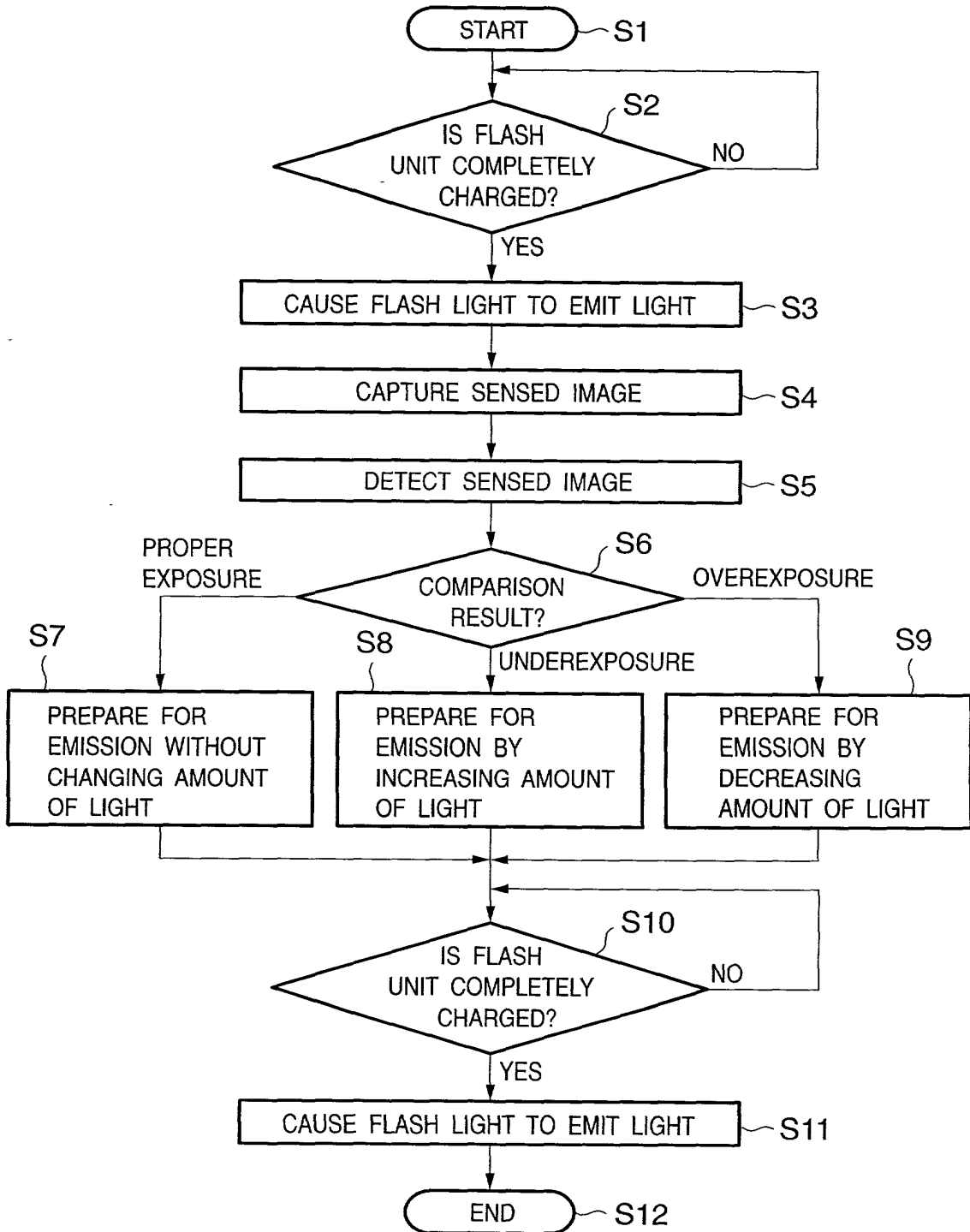
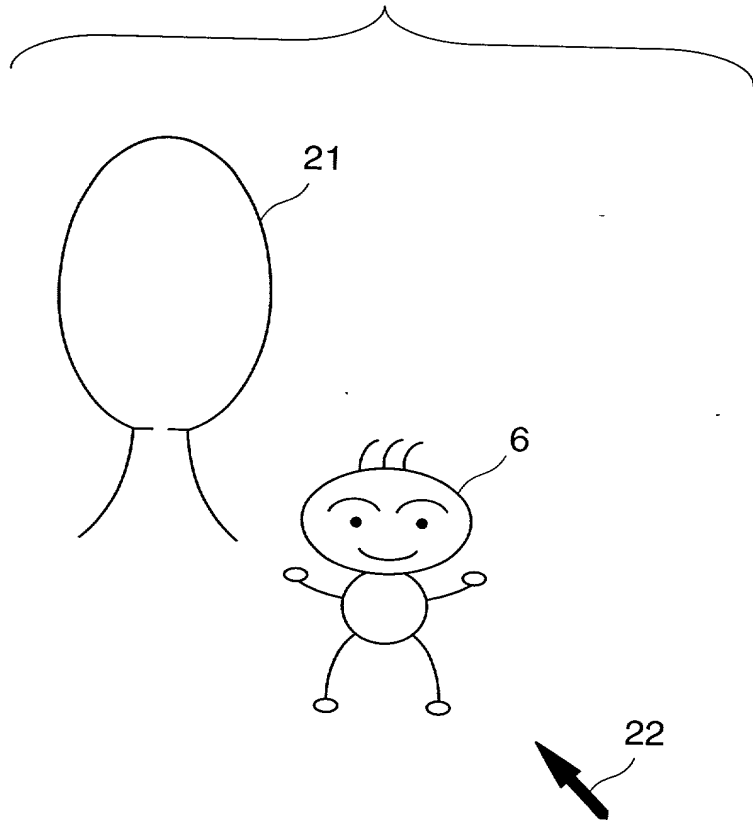

FIG. 3



FO900-916460

FIG. 4



2025 RELEASE UNDER E.O. 14176

FIG. 5

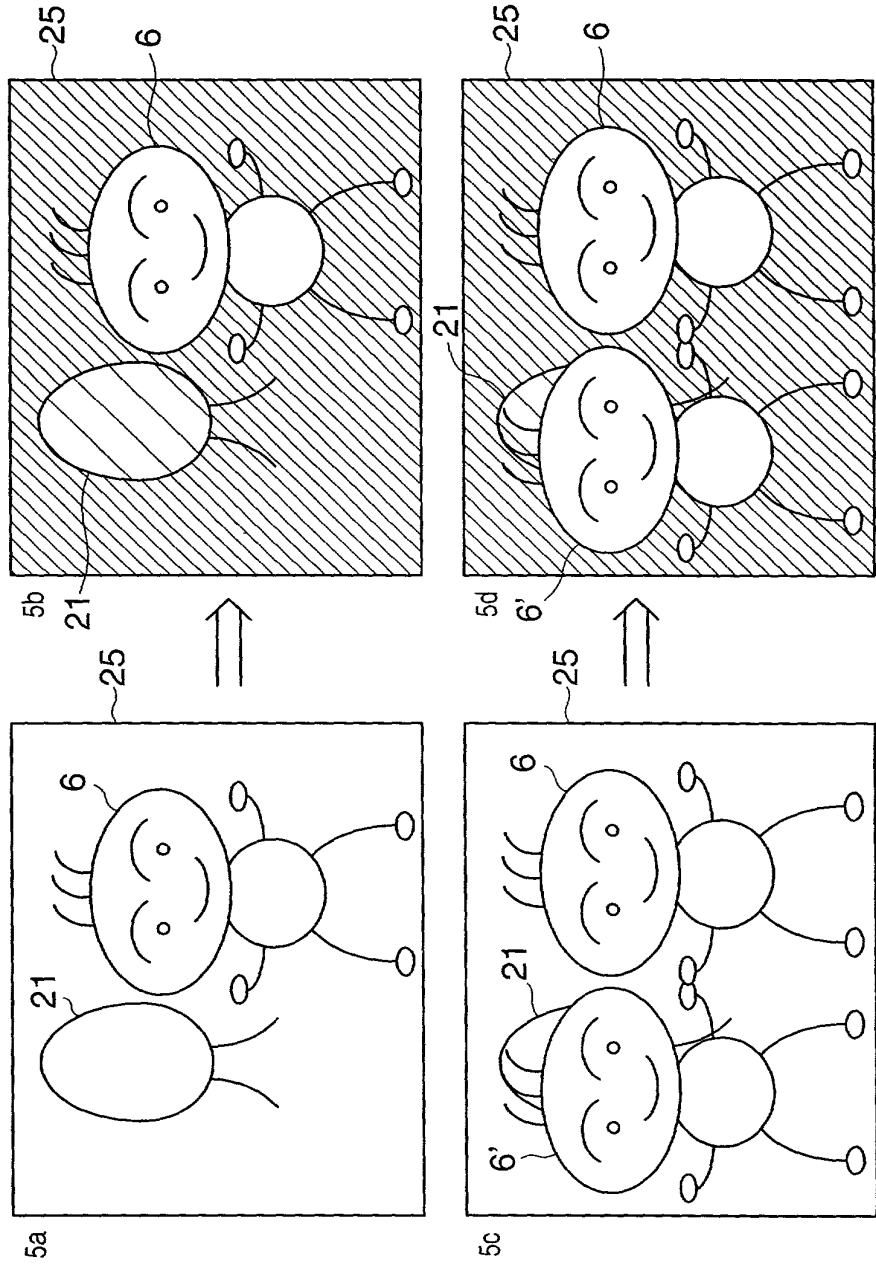

FIG. 6

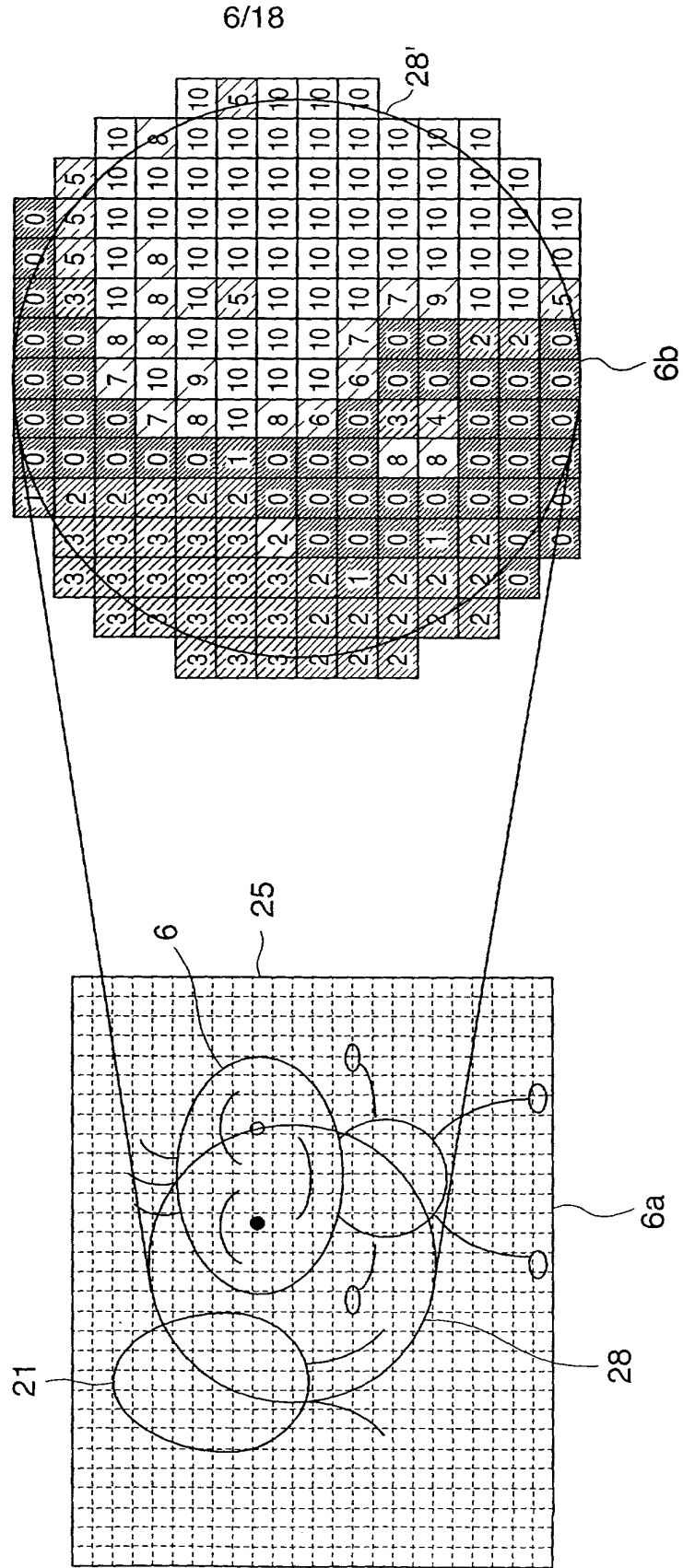

FIG. 7A

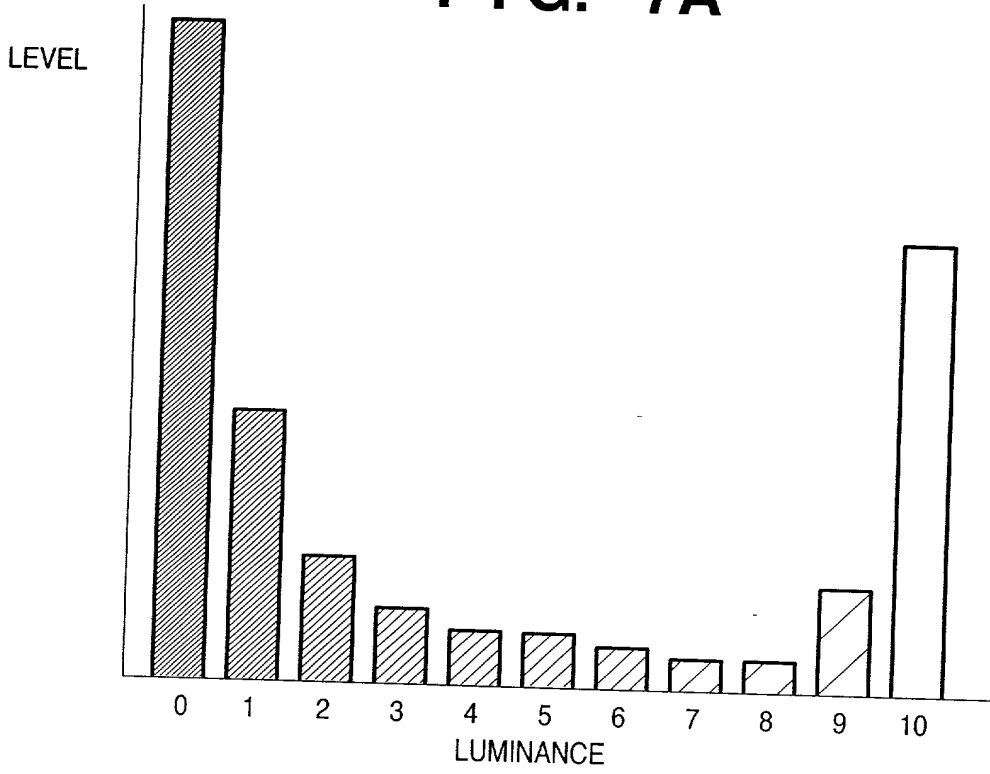

FIG. 7B

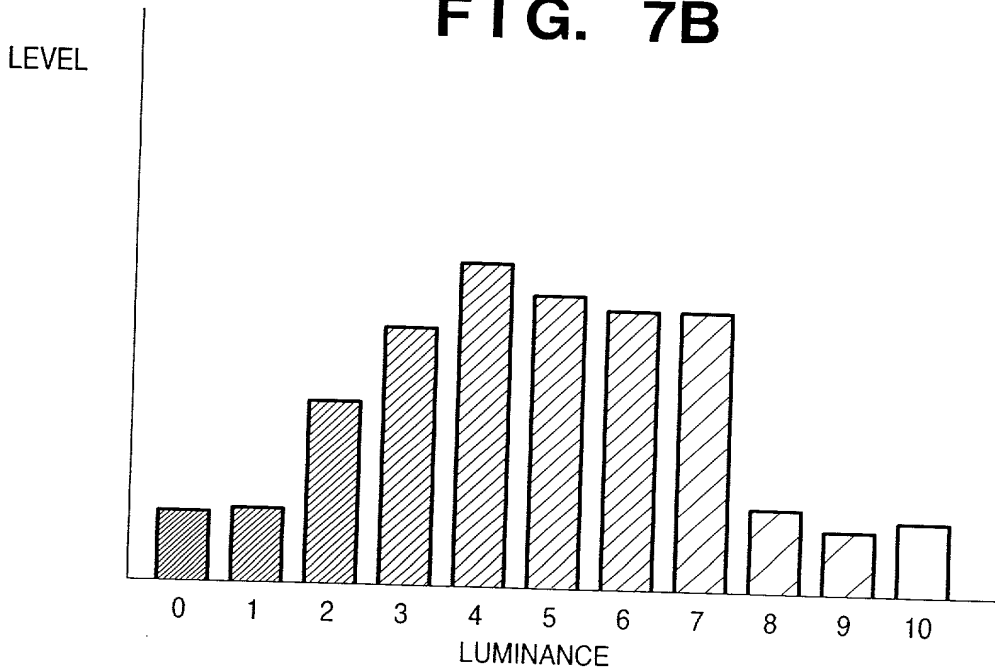

FIG. 8

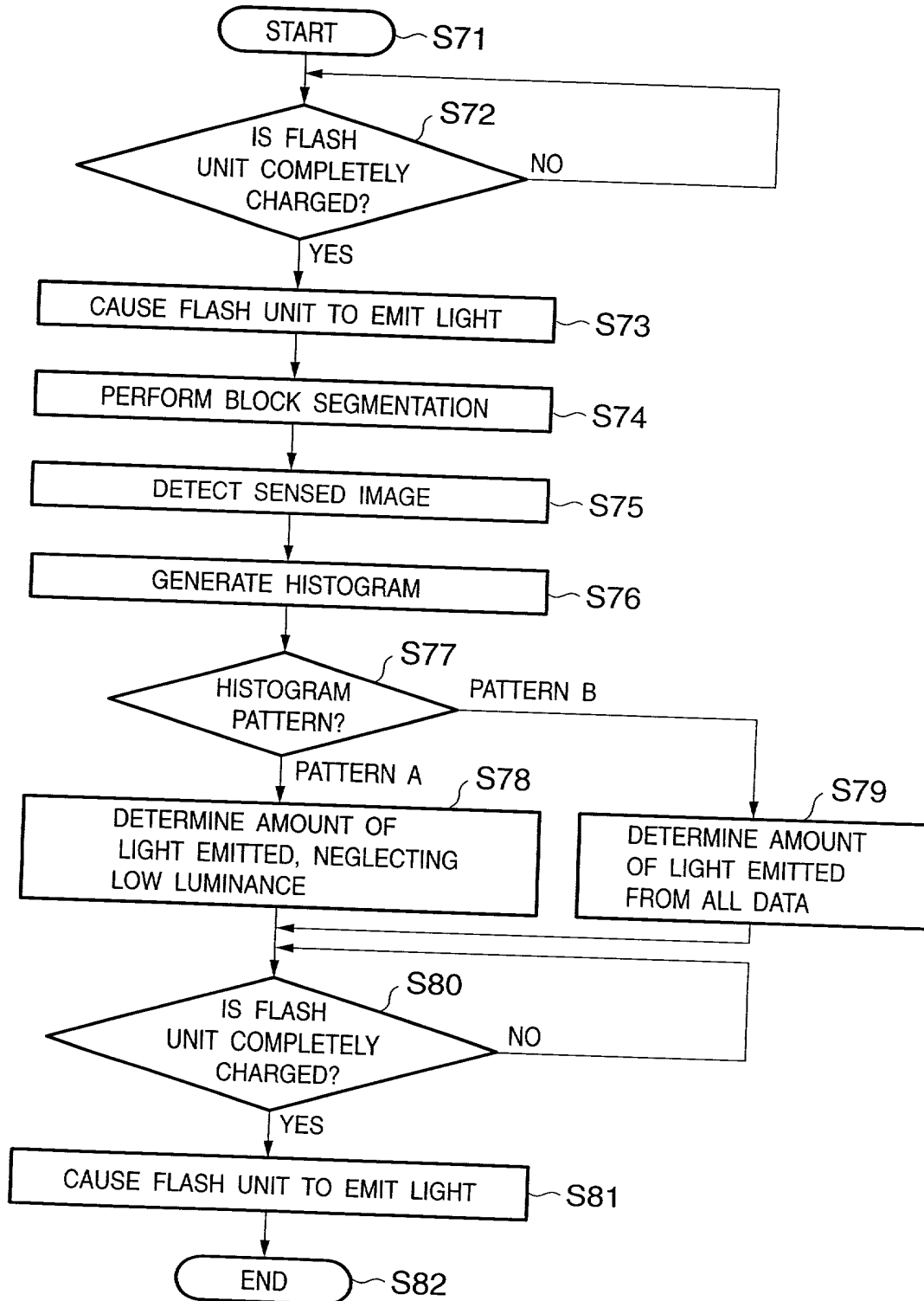

FIG. 8

FIG. 9

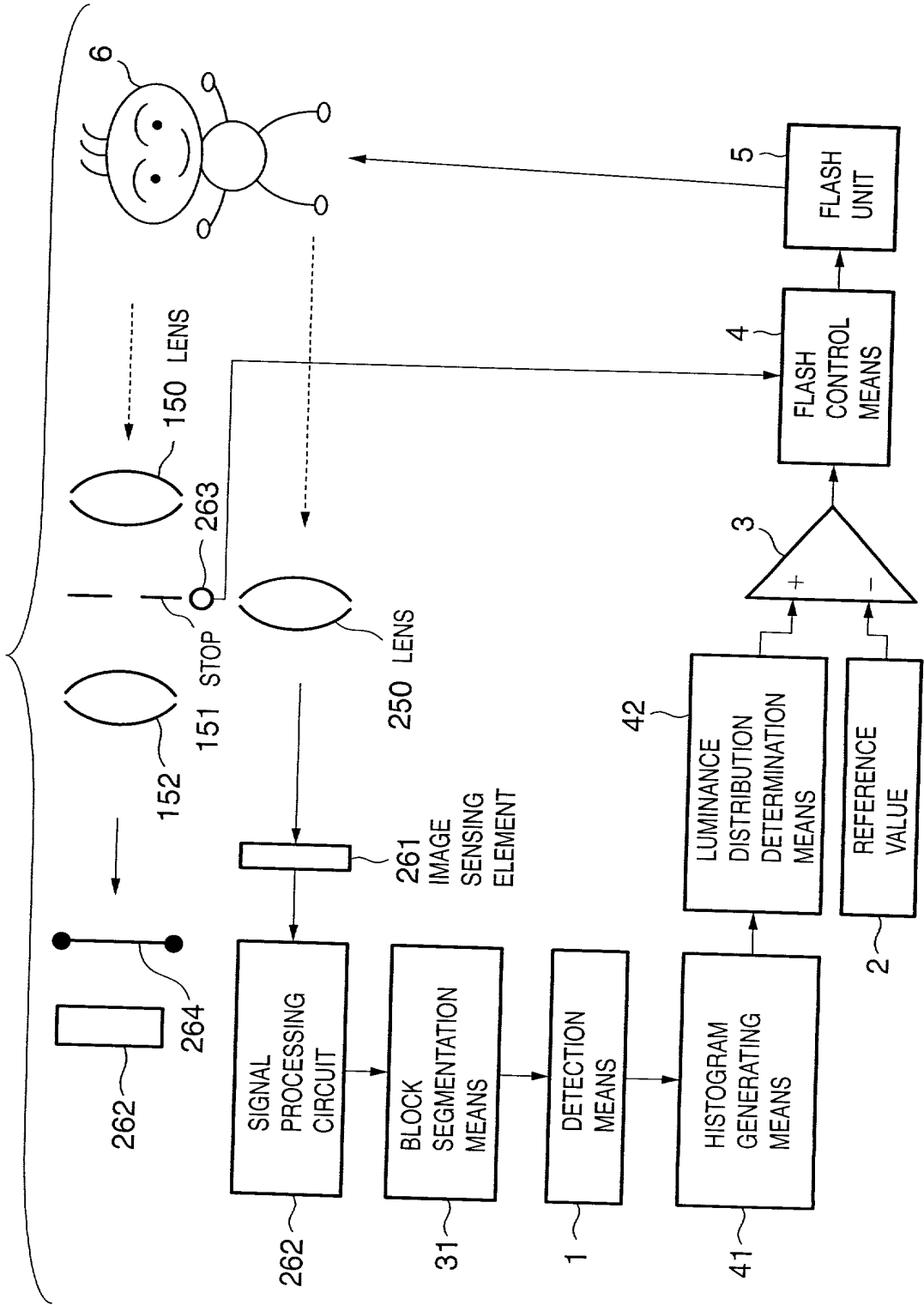

FIG. 10A

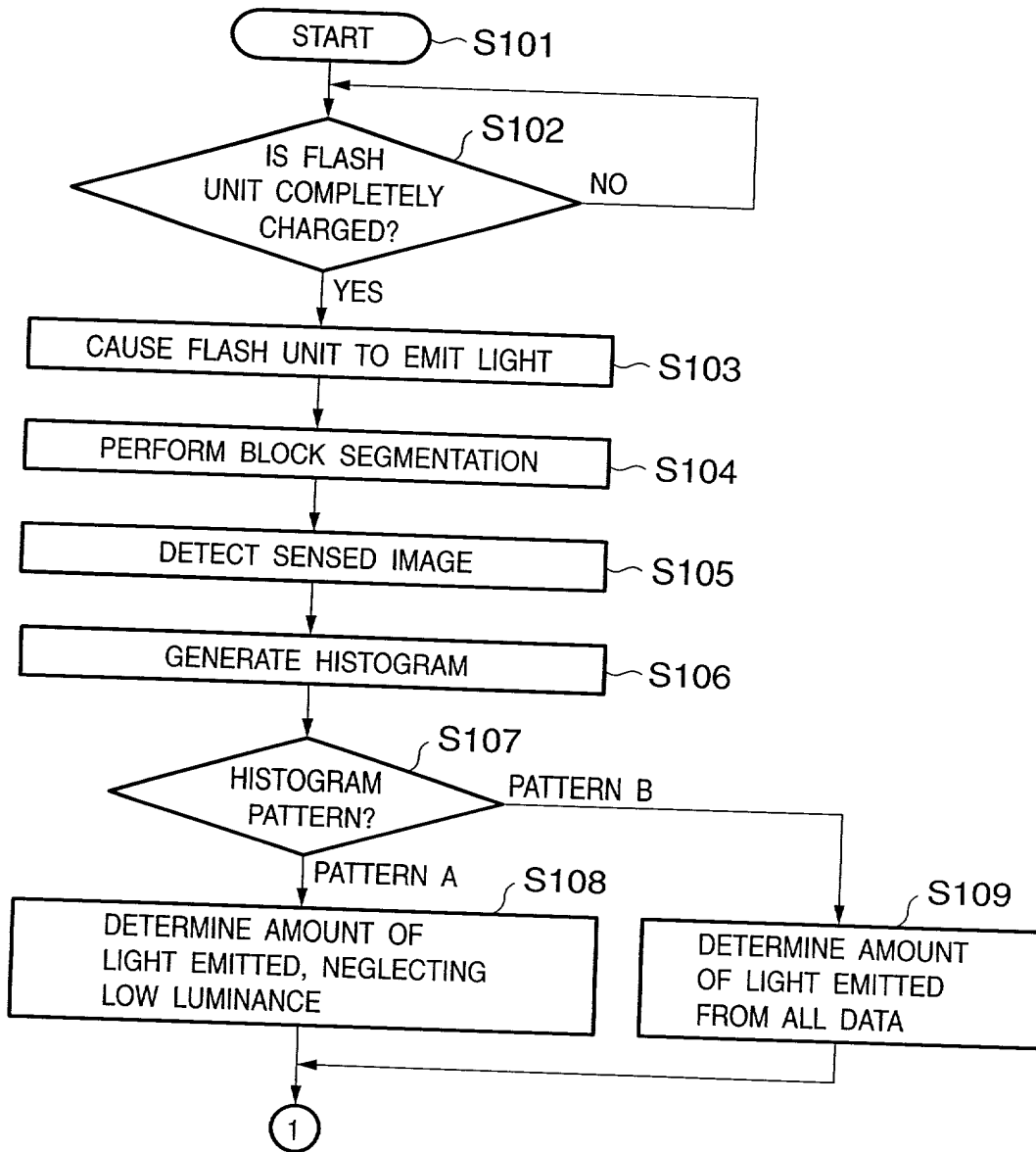

FIG. 10A

FIG. 10B

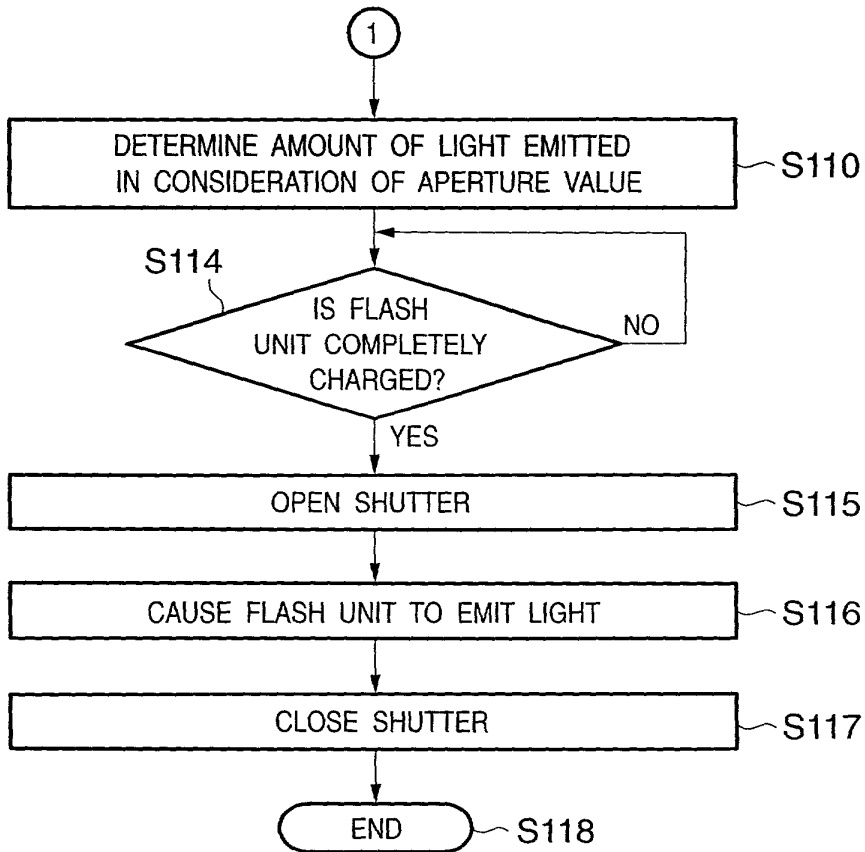

FIG. 10B

FIG. 11

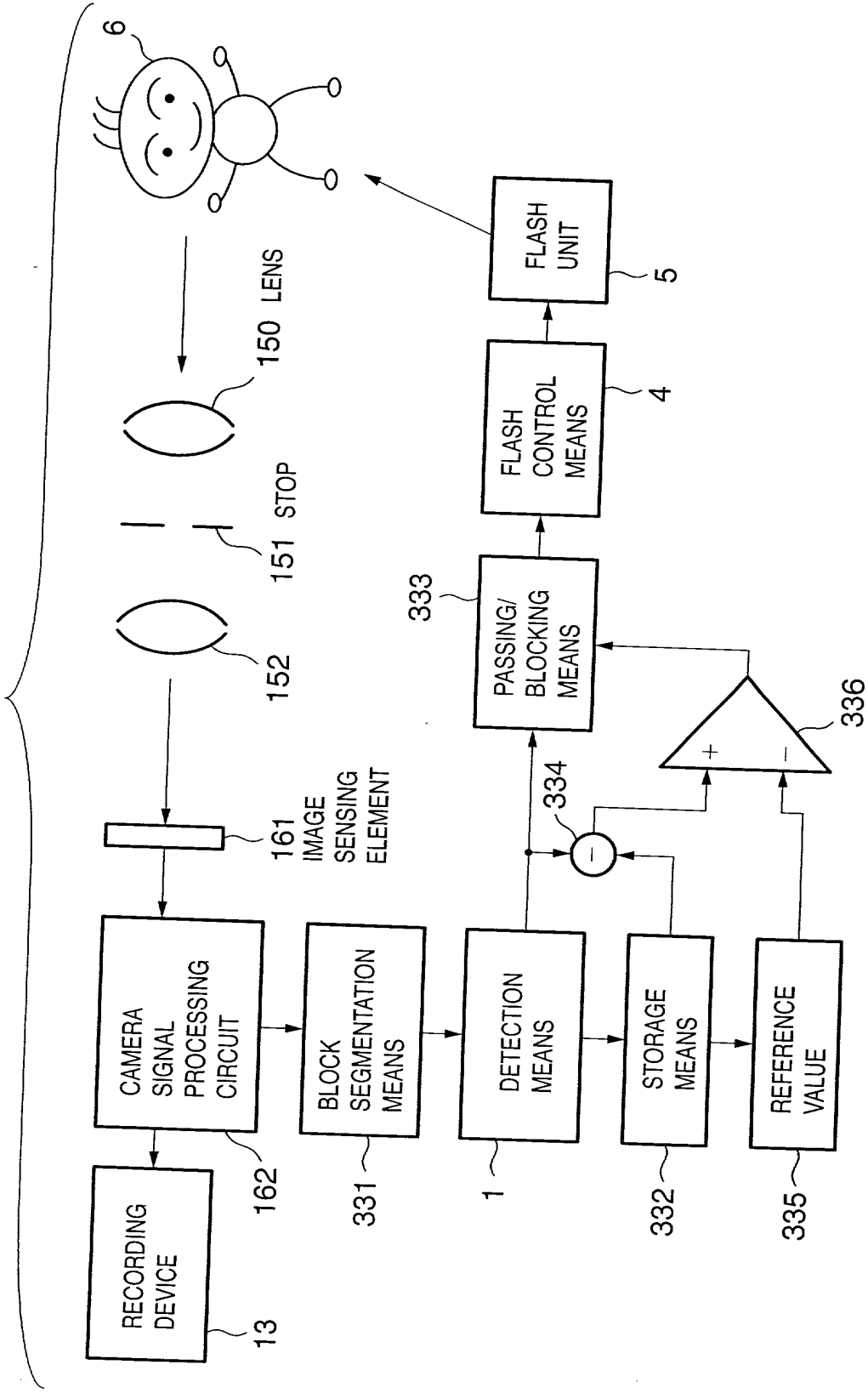

FIG. 12A

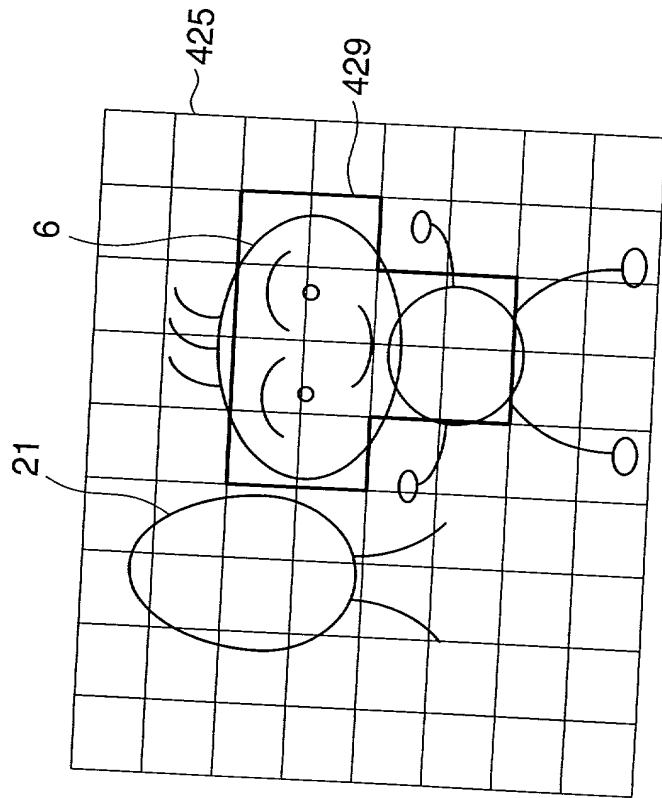

FIG. 12B

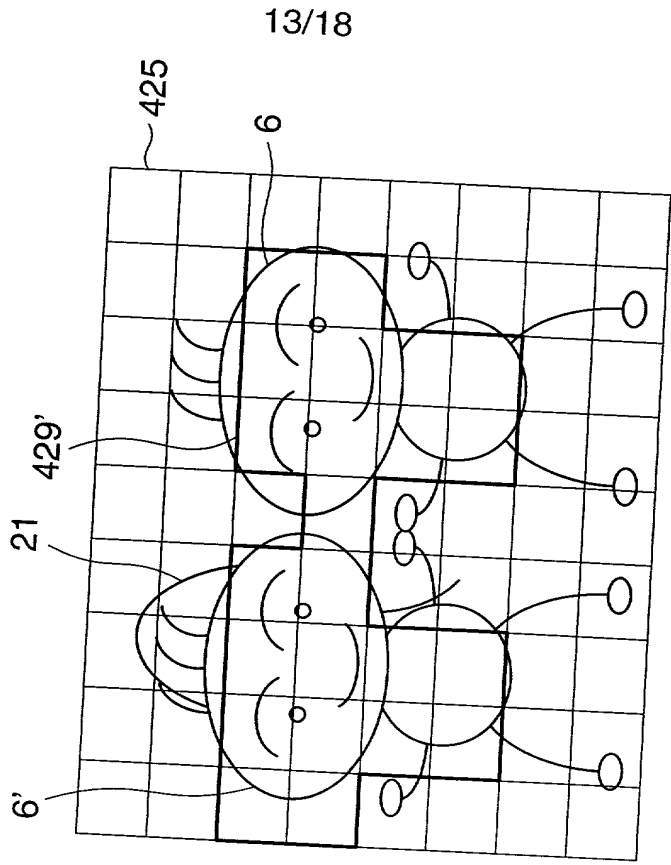

FIG. 13A

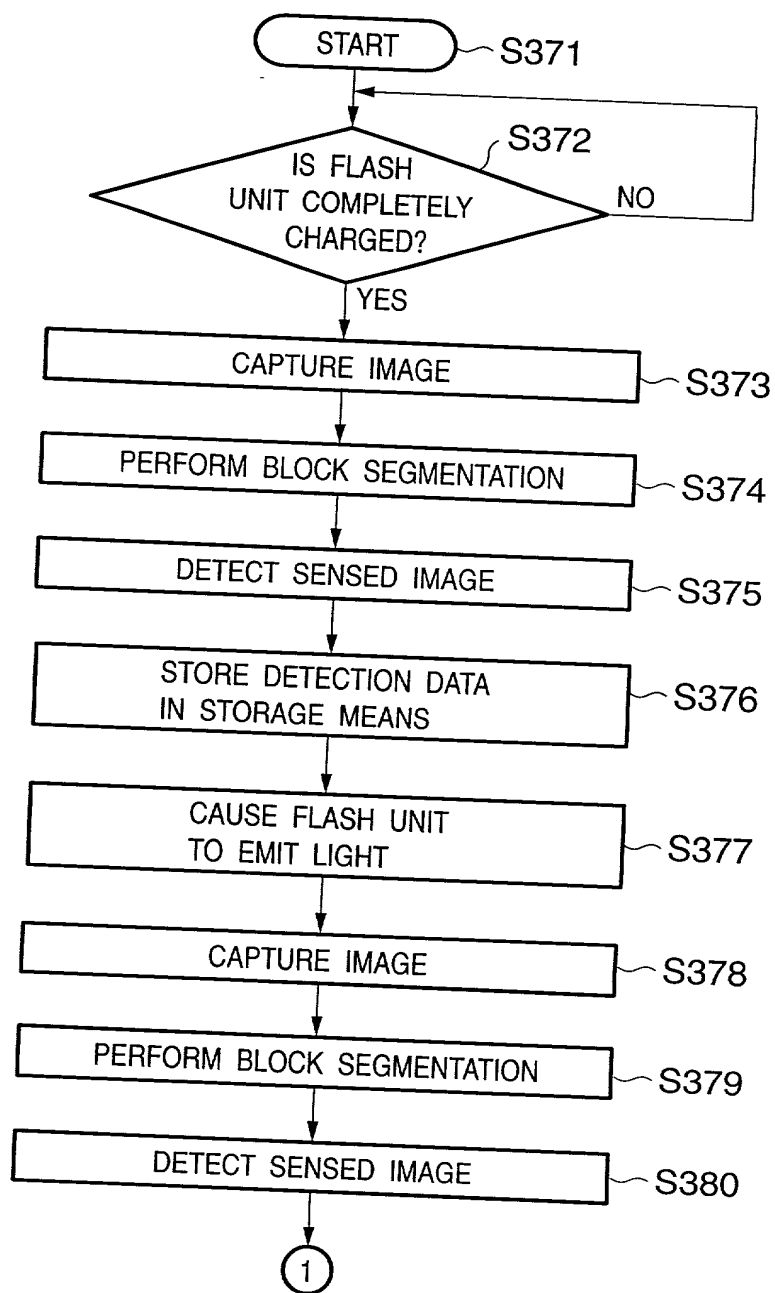

FIG. 13A

FIG. 13B

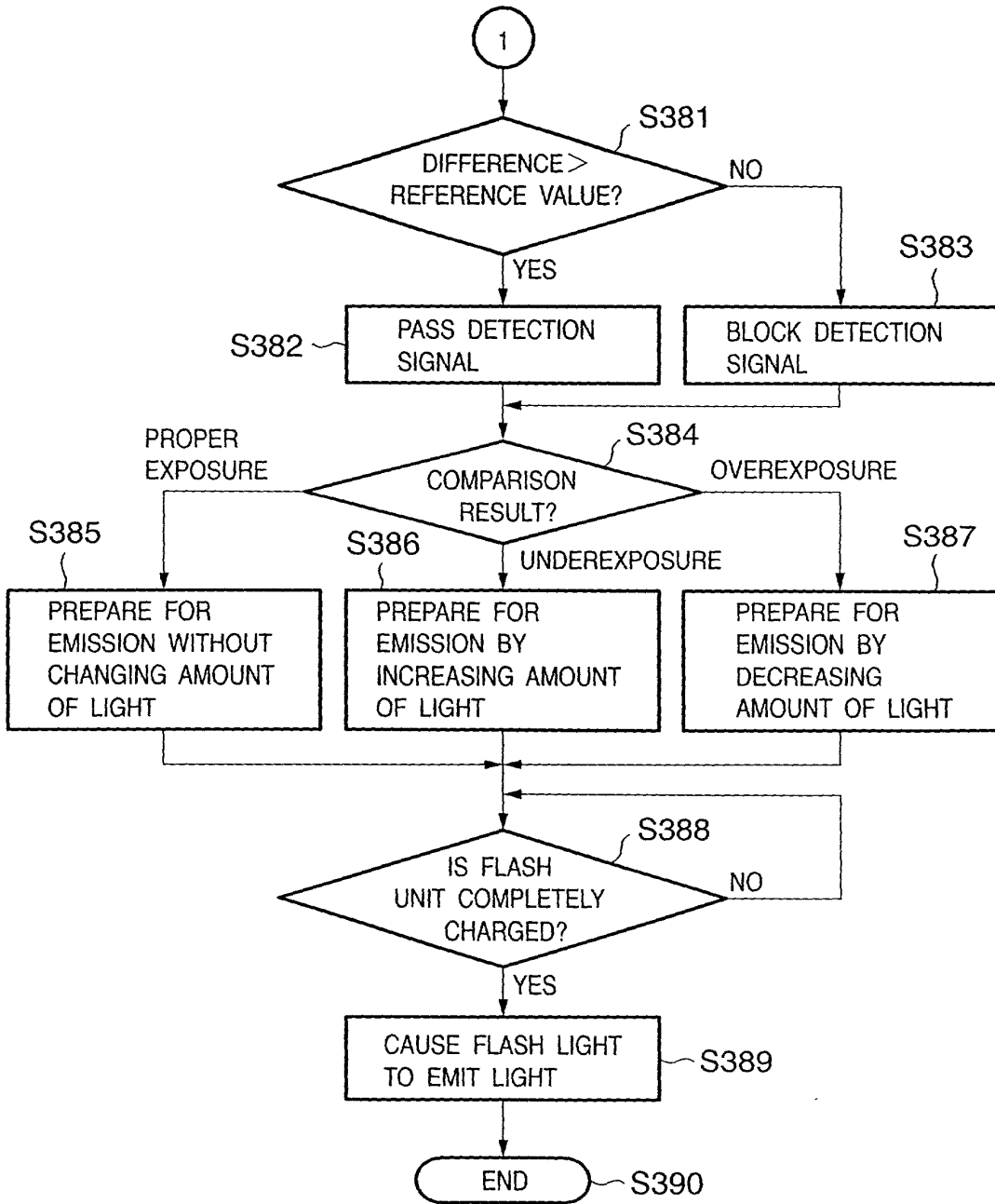

FIG. 13B

FIG. 14

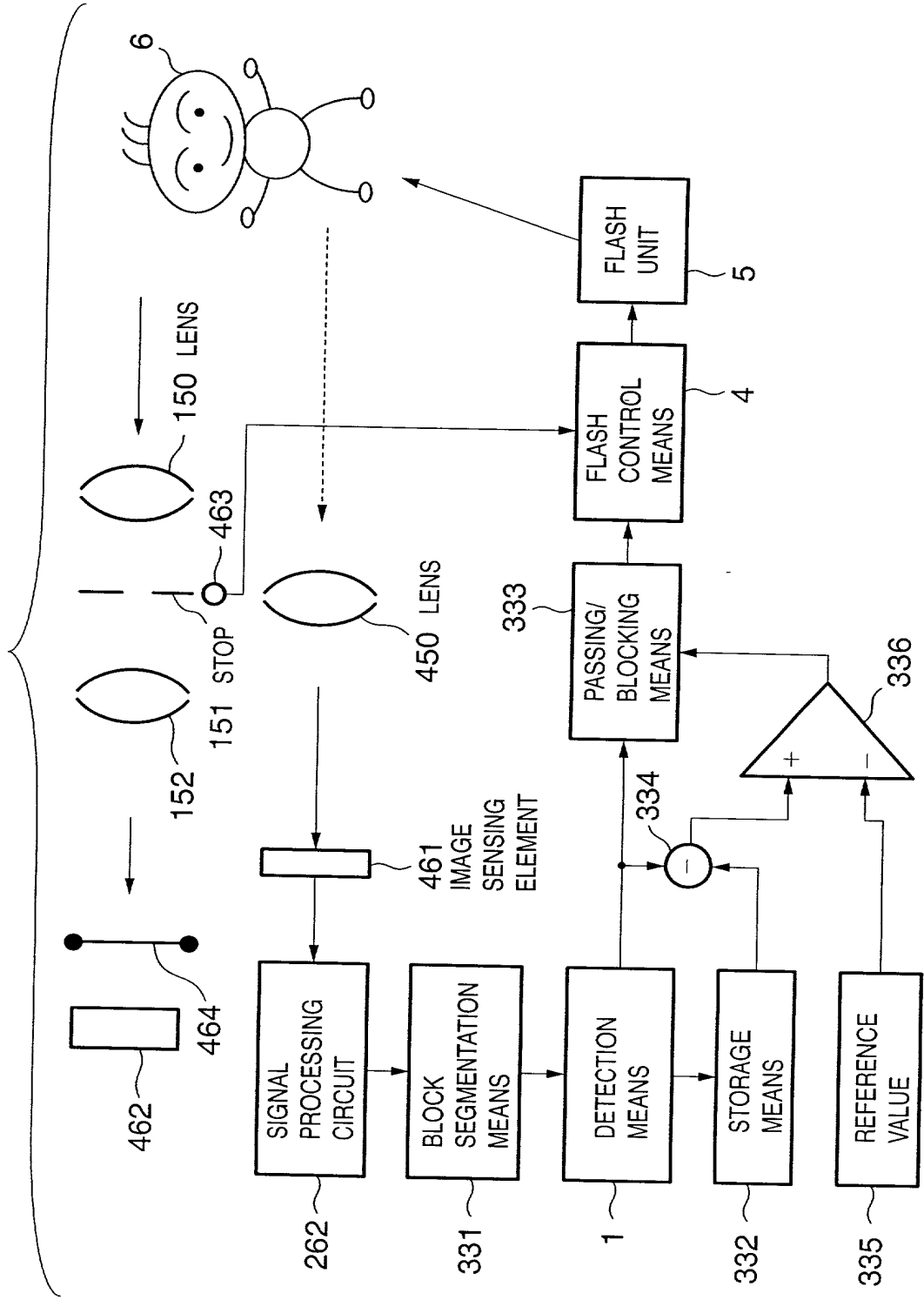

FIG. 15A

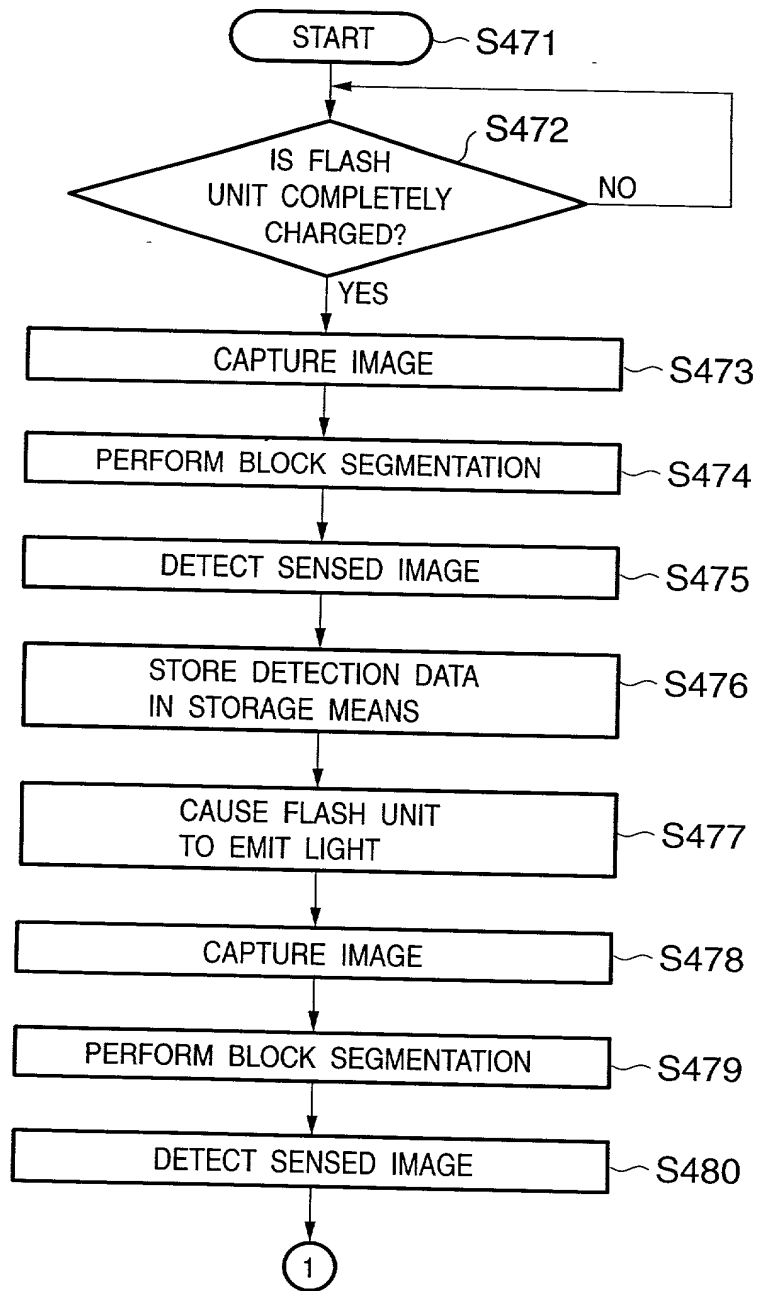
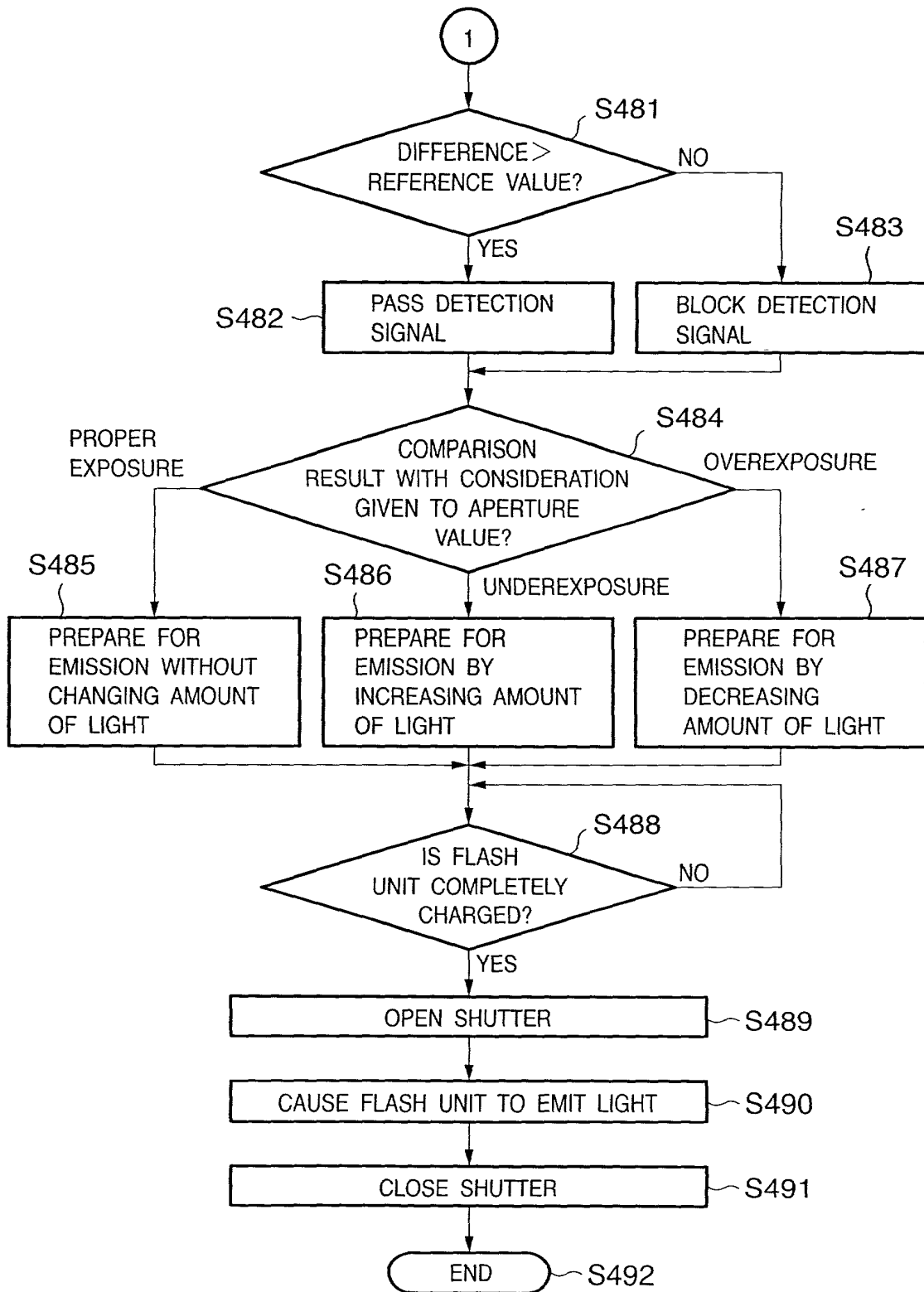

FIG. 15A

FIG. 15B



FOUO 9/16/2000